

DS Trenntransformator nach VDE 0570, EN 61558-2-1, 2-2, 2-4, 2-6

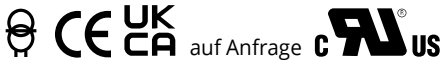

Dreiphasen Transformator

Korrosions- und Feuchtigkeitsschutz durch komplette Harz-Imprägnierung, max. Umgebungstemperatur 40°C, Isolationsklasse B, Schutzart IP 00, zum Einbau bis IP 23, vorbereitet für Schutzklasse I, berührungsgeschützter Schraubanschluss nach DGUV Vorschrift 3 oder Anschluss an Cu-Fahnen, getrennte Wicklungen, Frequenz 50-60 Hz

Eingangsspannung: 3x 100V - 750V
Ausgangsspannung: 3x 5V - 750V

Three-phase transformer

Protection against humidity due and rusting by complete impregnation, max. ambient temperature 40°C, insulation class B, protection system IP 00, for installation up to IP 23, prepared for protection class I, connections for screw terminals according to DGUV Regulation 3 or flat copper connection, seperated windings, frequency 50-60 Hz

rated supply voltage: 3x 100V - 750V
rated output voltage: 3x 5V - 750V

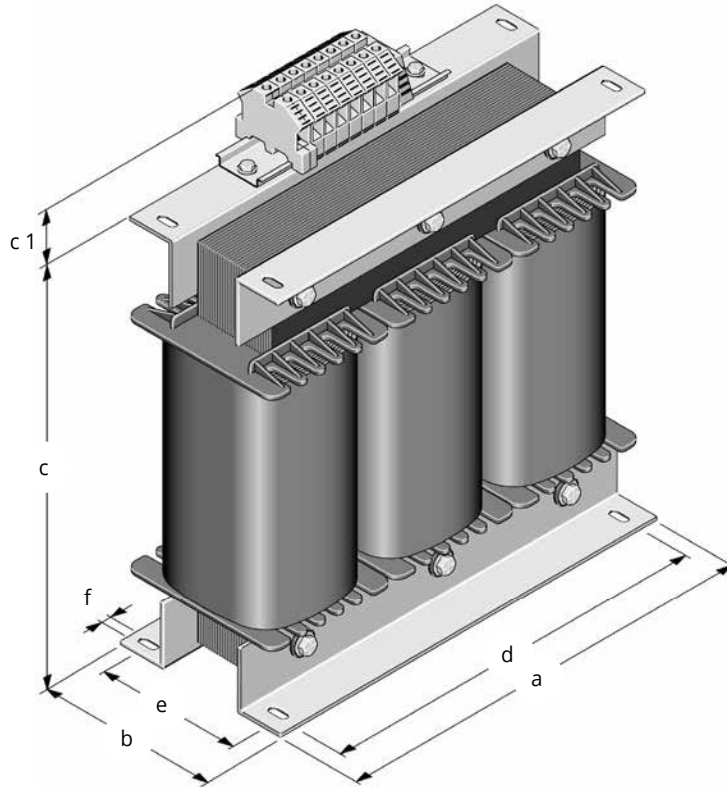

stehende Bauart / vertical design

Typ type	Leistung Rating KVA	a mm	b mm	c mm	c 1 mm	d mm	e mm	f mm	Gewicht weight kg
DS 0,10	0,10	125	71	110	40 - 60	100	55	5,0	2,7
DS 0,20	0,20	155	77	135	40 - 60	130	57	8,0	4,0
DS 0,30	0,30	155	95	135	40 - 60	130	74	8,0	5,0
DS 0,50	0,50	190	91	160	60 - 90	170	68	8,0	8,0
DS 0,75	0,75	190	105	160	60 - 90	170	80	8,0	12,0
DS 1,00	1,00	240	121	210	60 - 90	190	96	11,0	15,5
DS 1,50	1,50	240	141	210	60 - 90	190	116	11,0	21,0
DS 2,00	2,00	240	155	210	60 - 90	190	130	11,0	26,0
DS 2,50	2,50	265	152	230	60 - 90	215	127	11,0	30,0
DS 3,00	3,00	300	165	270	60 - 90	240	134	11,0	37,0
DS 4,00	4,00	300	192	270	60 - 90	240	161	11,0	47,0
DS 5,00	5,00	360	163	312	60 - 90	310	126	11,0	52,0
DS 6,30	6,30	360	193	312	60 - 90	310	156	11,0	70,0
DS 7,50	7,50	360	193	312	60 - 90	310	156	11,0	75,0
DS 8,80	8,80	420	197	365	60 - 90	370	152	11,0	78,0
DS 10,00	10,00	420	223	365	60 - 90	370	182	11,0	100,0
DS 12,50	12,50	420	253	365	60 - 90	370	212	11,0	118,0
DS 15,00	15,00	420	253	365	60 - 90	370	212	11,0	140,0

HIERVON ABWEICHENDE SPANNUNGEN UND LEISTUNGEN AUF ANFRAGE.

OTHER VOLTAGES AND RATINGS AVAILABLE UPON REQUEST.