

# NL Trenntransformator nach VDE 0570 DIN EN 61558-2-1, -2, -4, -6



## Einphasen Netztransformator

Korrosions- und Feuchtigkeitsschutz durch komplette Harz-Imprägnierung, max. Umgebungstemperatur 40°C, Isolationsklasse B, Schutzart IP 00, zum Einbau bis IP 23, vorbereitet für Schutzklasse I, berührungsgeschützter Schraubanschluss nach DGUV Vorschrift 3, getrennte Wicklung, Frequenz 50-60 Hz

**Eingangsspannung:** 100V - 750V  
**Ausgangsspannung:** 5V - 750V

## Single-phase isolating transformer

Protection against humidity due and rusting by complete impregnation, maximum ambient temperature 40°C, insulation class B, protection system IP 00, for installation up to IP 23, prepared for protection class I, connections for screw terminals according to DGUV Regulations 3, separated winding, frequency 50-60 Hz

**rated supply voltage:** 100V - 500V  
**rated output voltage:** 5V - 750V

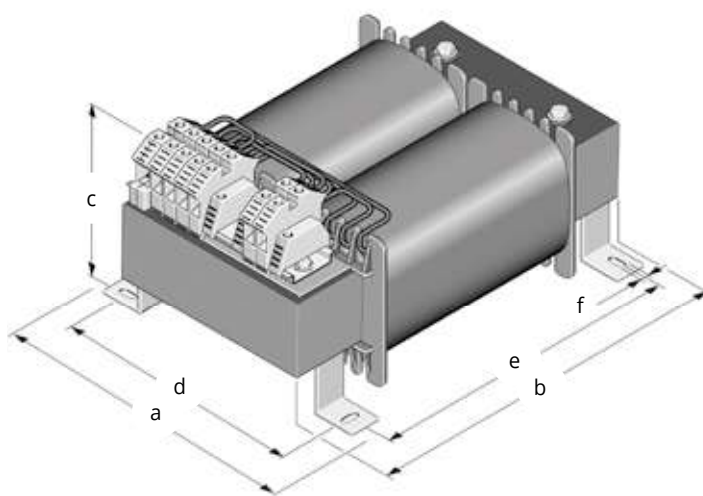

### liegende Bauart / horizontal design

Typ type	Leistung rating KVA	a mm	b mm	c mm	d mm	e mm	f mm	Gewicht weight kg
NL 2,0	2,0	166	250	170	146	176	7,0	20,0
NL 2,5	2,5	195	280	170	174	200	7,0	23,0
NL 3,0	3,0	195	280	180	174	200	7,0	27,5
NL 3,5	3,5	230	340	170	204	240	9,0	34,5
NL 4,0	4,0	230	340	170	204	240	9,0	35,0
NL 4,5	4,5	230	340	185	204	240	9,0	40,0
NL 5,0	5,0	230	340	200	204	240	9,0	46,5
NL 6,3	6,3	260	390	190	234	280	9,0	54,0
NL 7,5	7,5	260	390	205	234	280	9,0	63,0
NL 8,8	8,8	260	390	220	234	280	9,0	77,0
NL 10,0	10,0	260	390	250	234	280	9,0	91,0