

# MDsp Spartransformator nach VDE 0570 DIN EN 61558-2-13



## Dreiphasen Spartransformator

Korrosions- und Feuchtigkeitsschutz durch komplette Harz-Imprägnierung, max. Umgebungstemperatur 40°C, Isolationsklasse F, Schutzart IP 00, zum Einbau bis IP 23, Frequenz 50-60 Hz

**Eingangsspannung:** 3x 100V - 750V  
**Ausgangsspannung:** 3x 100V - 750V  
**Anschluss:** < 140A Reihenklemmen  
 > 140A Kupferlaschen

## Three-phase auto transformer

Protection against humidity due and rusting by complete impregnation, maximum ambient temperature 40°C, insulation class F, protection system IP 00, for installation up to IP 23, frequency 50-60 Hz

**rated supply voltage:** 3x 100V - 750V  
**rated output voltage:** 3x 100V - 750V  
**connection:** < 140A terminals  
 > 140A flat copper connection

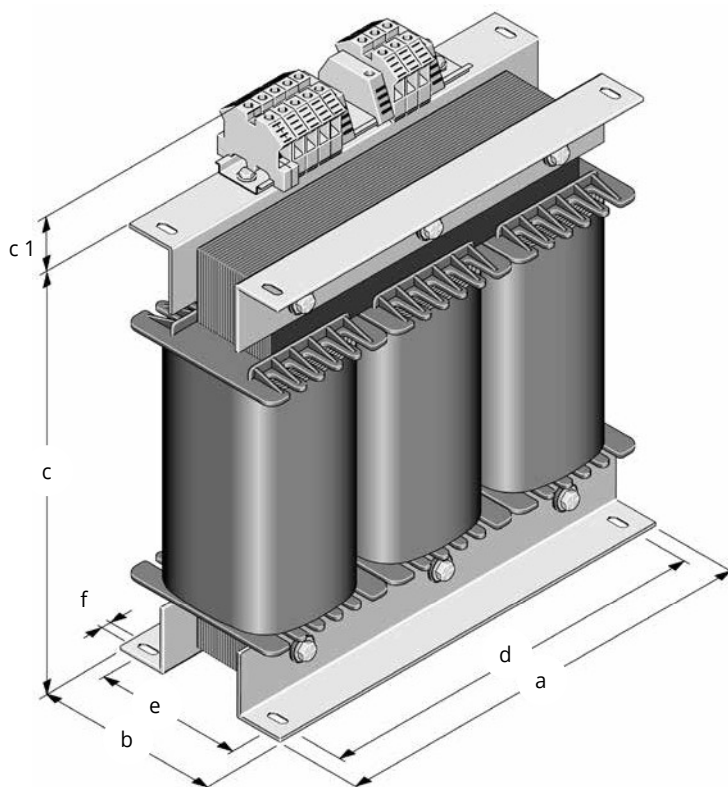

stehende Bauart / vertical design

Typ type	Bauleistung core power KVA	a mm	b mm	c mm	c 1 mm	d mm	e mm	f mm	Gewicht weight kg
MDsp 2	12,50	480	215	460	60 - 90	430	170	9,0	88,0
MDsp 2	15,00	480	215	460	60 - 90	430	170	9,0	91,0
MDsp 3	17,50	480	230	460	60 - 90	430	188	9,0	110,0
MDsp 3	20,00	480	230	460	60 - 90	430	188	9,0	115,0
MDsp 4	25,00	480	245	460	60 - 90	430	203	9,0	125,0
MDsp 5	30,00	480	275	460	60 - 90	430	233	9,0	144,0
MDsp 6	35,00	540	275	520	60 - 90	450	180	9,0	178,0
MDsp 6	40,00	540	275	520	60 - 90	450	180	9,0	189,0
MDsp 7	50,00	540	365	520	60 - 90	450	210	9,0	210,0
MDsp 8	63,00	700	310	580	60 - 90	640	200	11,0	285,0
MDsp 9	75,00	700	340	580	60 - 90	640	230	11,0	320,0
MDsp 9	90,00	700	340	580	60 - 90	640	230	11,0	335,0
MDsp 10	100,00	700	370	580	60 - 90	640	260	13,0	420,0
MDsp 11	135,00	840	450	640	60 - 90	740	230	13,0	515,0
MDsp 12	160,00	840	480	780	60 - 90	740	260	13,0	640,0

HIERVON ABWEICHENDE SPANNUNGEN UND LEISTUNGEN AUF ANFRAGE.

OTHER VOLTAGES AND RATINGS AVAILABLE UPON REQUEST.